

# Table of Contents









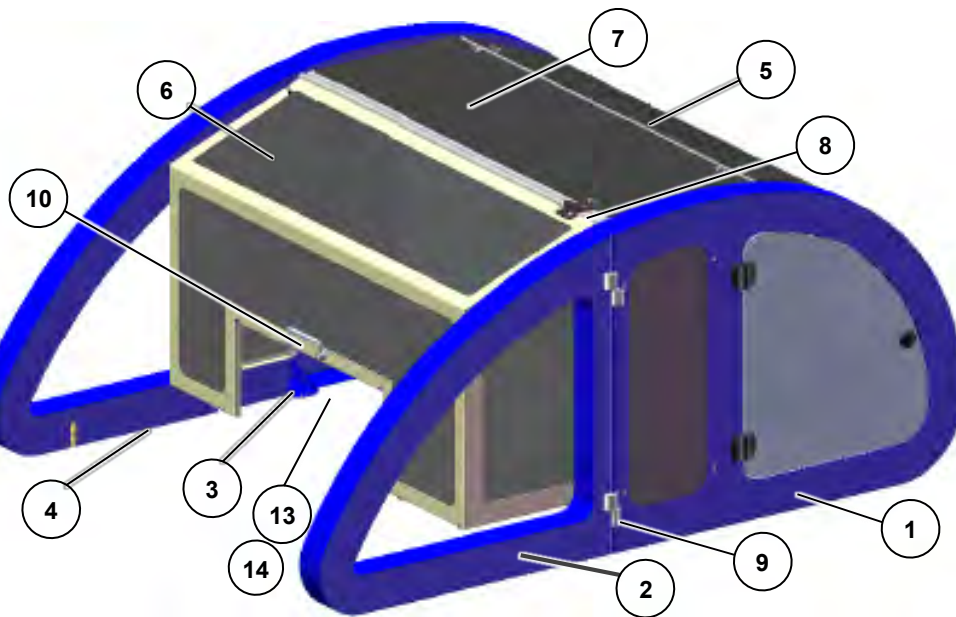

<b>Introducing the Kornit Breeze Parts Catalog</b> .....	<b>6</b>
<b>Overview</b> .....	<b>6</b>
<b>Parts</b> .....	<b>7</b>
<b>Covers</b> .....	<b>7</b>
Hood (33-HOOD-0007).....	7
<b>Front View</b> .....	<b>8</b>
Emergency Switch (23-SWTC-0002).....	8
Right Front Panel Assembly (33-PANL-0009).....	8
Pallets .....	9
<b>The Axes</b> .....	<b>11</b>
The Cross-scan (x) Axis Assembly (33-AXIS-0019) .....	12
Scan Axis (y) Assembly (33-AXIS-0020) .....	13
Scan Axis – Ink Tanks, Main Board and Sprinkler Assemblies (33-YSTG-0002) ....	14
Spray Sprinkler Assembly, Delrin+SST Parts (33-NVAL-0010).....	15
Print Heads Array Assembly (33-PHAS-0006).....	16
<b>Left View</b> .....	<b>17</b>
Pneumatic Panel (33-ELEC-0003).....	18
Spray Container Tank Assembly (33-SPRY-0018) .....	19
<b>Right View</b> .....	<b>20</b>
Maintenance Assembly (33-MAIN-0015) .....	21
Secondary Pneumatic Panel Assembly (33-ELCS-0001) .....	23
<b>Rear View (Internal)</b> .....	<b>24</b>
Power Supplies .....	25
Fuses and Circuit Breakers.....	25
Wiping System (33-WIPR-0027) .....	26
Motor Gear Assembly (33-GEAR-0005).....	27
Electrical System V1 (33-ELEC-0002) .....	28
Electrical Upper Shelf Assembly (33-ELSH-0002) .....	29
<b>Chemicals</b> .....	<b>30</b>
<b>Accessories</b> .....	<b>30</b>
<b>Maintenance Kits &amp; Upgrades</b> .....	<b>31</b>
<b>Electronic Cards</b> .....	<b>31</b>
<b>Cables</b> .....	<b>31</b>
<b>Appendix: Returning Parts Procedure</b> .....	<b>33</b>

## Parts

### Covers

#### Hood (33-HOOD-0007)



#	Catalog #	Description	
1	33-COVR-0049	Right Rear Cover Assembly	
2	33-COVR-0050	Right Front Cover Assembly	
3	33-COVR-0048	Left Rear Cover Assembly	
4	33-COVR-0051	Left Front Cover Assembly	
5	33-WIND-0007	Top Rear Window Assembly	
6	33-HOOD-0006	Front Hood	
7	33-COVR-0055	Top Cover Assembly	
8	49-HING-1042	Friction Hinge	
9	49-HING-0001	Offset Lift Off Hinge	
9A	36-HING-0005	Door Hinge Pin (Metal)	
10	49-HNDL-0006	Folding Handle	
11	06-SWTC-0003	Safety Coded Magnetic Switch 1 (under the hood near 49-HING-1042)	
12	09-KEAS-0231-S	Cable K-EAS-31 Door Interlock Safety Switch (under the hood)	
13	06-FLTR-0003	Compact Filter Power Entry Module 250VAC	
14	39-GURD-0012	Switch Protection Guard (for power inlet)	

# Front View

## Emergency Switch (23-SWTC-0002)

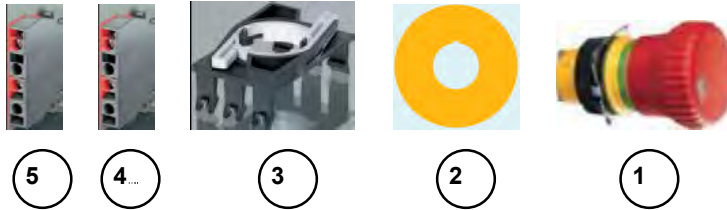

#	Catalog #	Description
1	32-0080	Emergency Stop
2	32-0085	Emergency Stop Sticker
3	32-0081	Button House
4	32-0082	Emergency Contact N.C.
5	32-0083	Emergency Contact N.O.

## Right Front Panel Assembly (33-PANL-0009)



#	Catalog #	Description	
1	09-KEAS-0205	Start Button Assembly (incl. wiring)	
2	06-EBRD-0204	LCD Panel Board	
3	06-FLTR-0003	AC Inlet - Compact Filter Power Entry Module 250VAC (not shown)	

## Pallets

### Standard Pallet Assembly 14" x 18" (33-PALT-0009)



#	Catalog #	Description
1	39-FRAM-0022	Table Frame (with frame coating: Rilsan® Bmno P40 TI Polyamide Resin)
2	36-PLAT-0152	Table Plate

### Children's Pallet Assembly V1 (33-PALT-0016): For machines up to 921-105

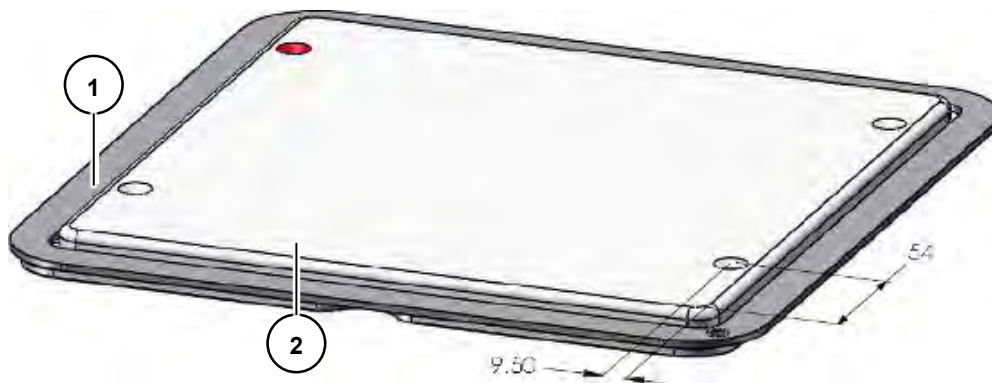

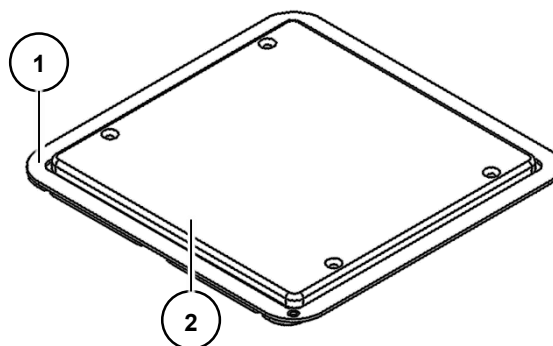

### Children's Pallet Assembly V2 (33-PALT-0031): For machines 921-106+



#	Catalog #	Description
1	39-FRAM-0037	Children Pallet Frame Assembly
2	33-PALT-0016,	Magnetic Children's Pallet Plate – for machines with serial no.: up to 921-105
	33-PALT-0031	Children's Pallet Plate – for machines with serial no.: up to 921-105
	36-PLAT-0005	Children's Pallet Plate – for machines with serial no.: 921-106+

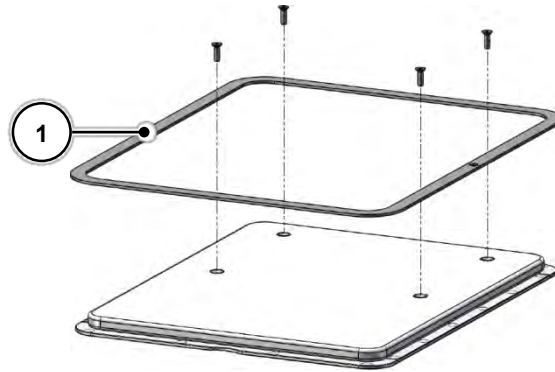





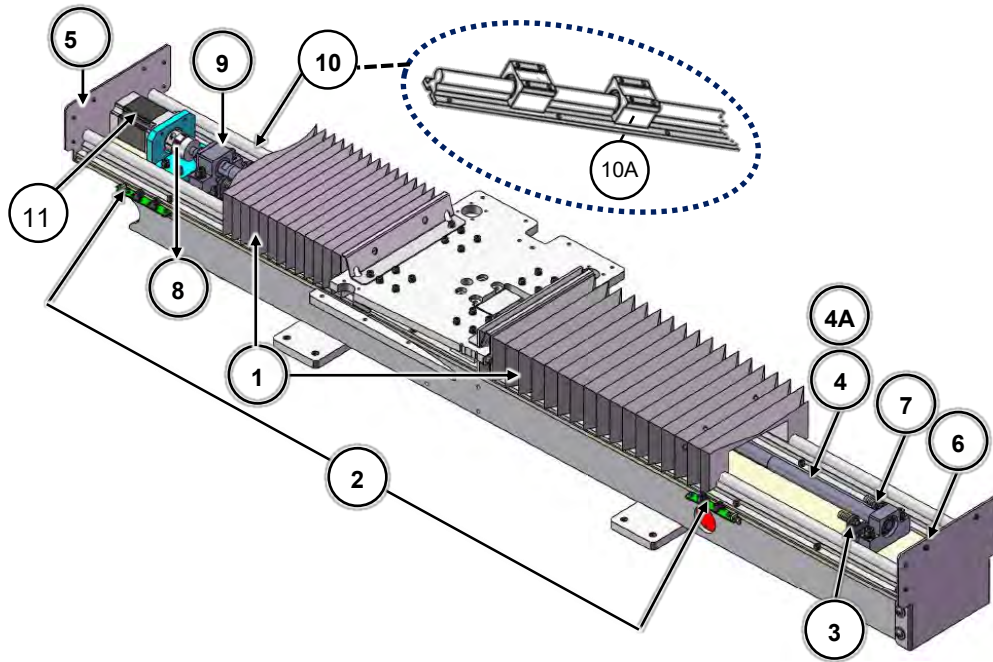

### 14" x 18" Pallet (33-PALT-0019)

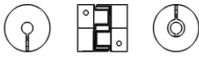

#	Catalog #	Description	
1	39-FRAM-0038	Pallet Frame 502 x 409 mm	







## The Cross-scan (x) Axis Assembly (33-AXIS-0019)

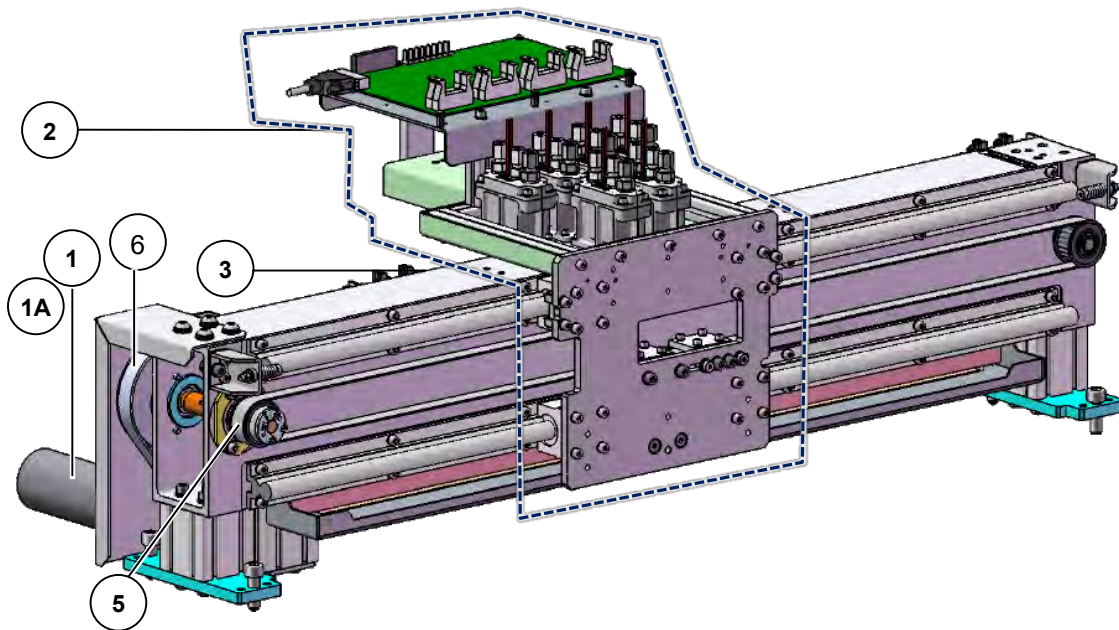

#	Catalog #	Description	
1	42-BELW-0004	921 Bellow	
2	06-EBRD-0002	Origin and Limit Sensor	
3	33-BUMP-0002	X Bumper Assembly	
4	42-SCRW-2020	Lead Screw	
4A	36-HOUS-0021	Nut Housing	
5	39-BRAK-0130	Back Bellow Bracket	
6	39-BRAK-0131	Front Bellow Bracket	
7	42-BSCS-0015	Ball Screw End Support	
8	42-COUP-0014	Coupling	
9	42-BSCS-0016	Ball Bearing Fixed Support	
10	42-LMBR-0005	1540 mm Linear Rail & 2 LM Blocks + Support Rail	 +  x2
10A	42-BEAR-0008	Bearing (Aluminum Case Unit Open SBR16UU Type)	
11	09-KEAS-0203-S	Wired Y Motor	 Wired

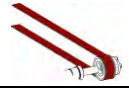

## Scan Axis (Y) Assembly (33-AXIS-0020)

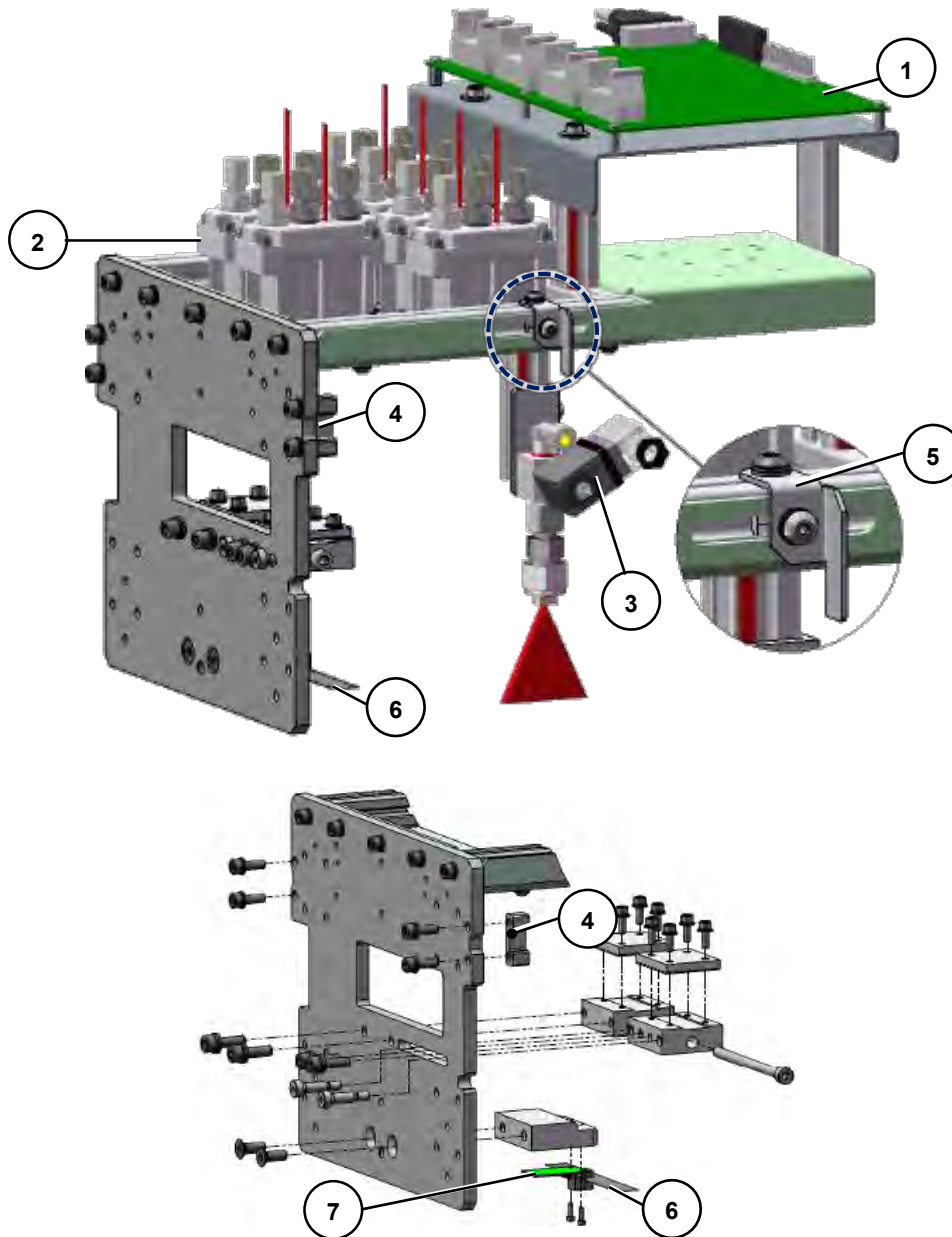

#	Catalog #	Description	
1	33-GEAR-0005	Scan Motor & Gear Assembly	
1A	09-KEAS-0203-S	Wired SCAN Motor for Breeze 921	
2	33-YSTG-0002	Ink Tanks Assembly (see page 14)	
3	06-EBRD-0002	Origin + Limit Sensor Assembled PCB	
4	42-LMBR-0011	920mm Linear Rail + 2 LM Blocks	
4A	42-BEAR-0007	Aluminum Case bearing Unit Open SBR16UU Type	
5	42-BELT-1920	Belt 1980mm	
6	42-BELT-0004	Drive Belt (Small Timing Belt)	
7	23-UPGR-0082	Encoder Upgrade Kit (Not shown in diagram)	

## Scan Axis – Ink Tanks, Main Board and Sprinkler Assemblies (33-YSTG-0002)





#	Catalog #	Description	
1	06-EBRD-0202	Head Board	
2	33-INKV-0005	Small Ink Tank Assembly	
3	33-NVAL-0010	Spray Sprinkler Assembly, Delrin+SST Parts (See below).	
4	36-HOLD-0039	Bumper Hold	
5	39-FLAG-0009	Sensor Flag	
6	23-UPGR-0082		

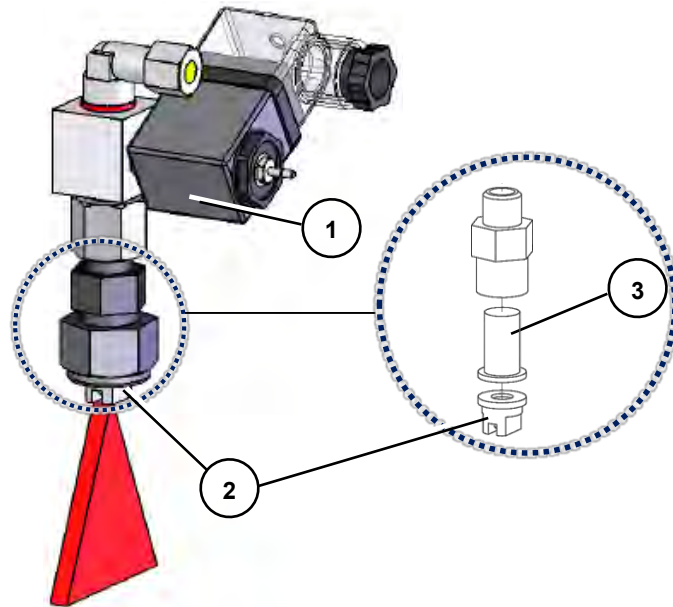

## Spray Sprinkler Assembly, Delrin+SST Parts (33-NVAL-0010)



#	Catalog #	Description	
1	03-COIL-0001	24V DC 5W Valve Coil	
2	03-NOZL-8001	Spray Nozzle 80 Degrees	
3	33-FLTR-6503	One-way Filter	



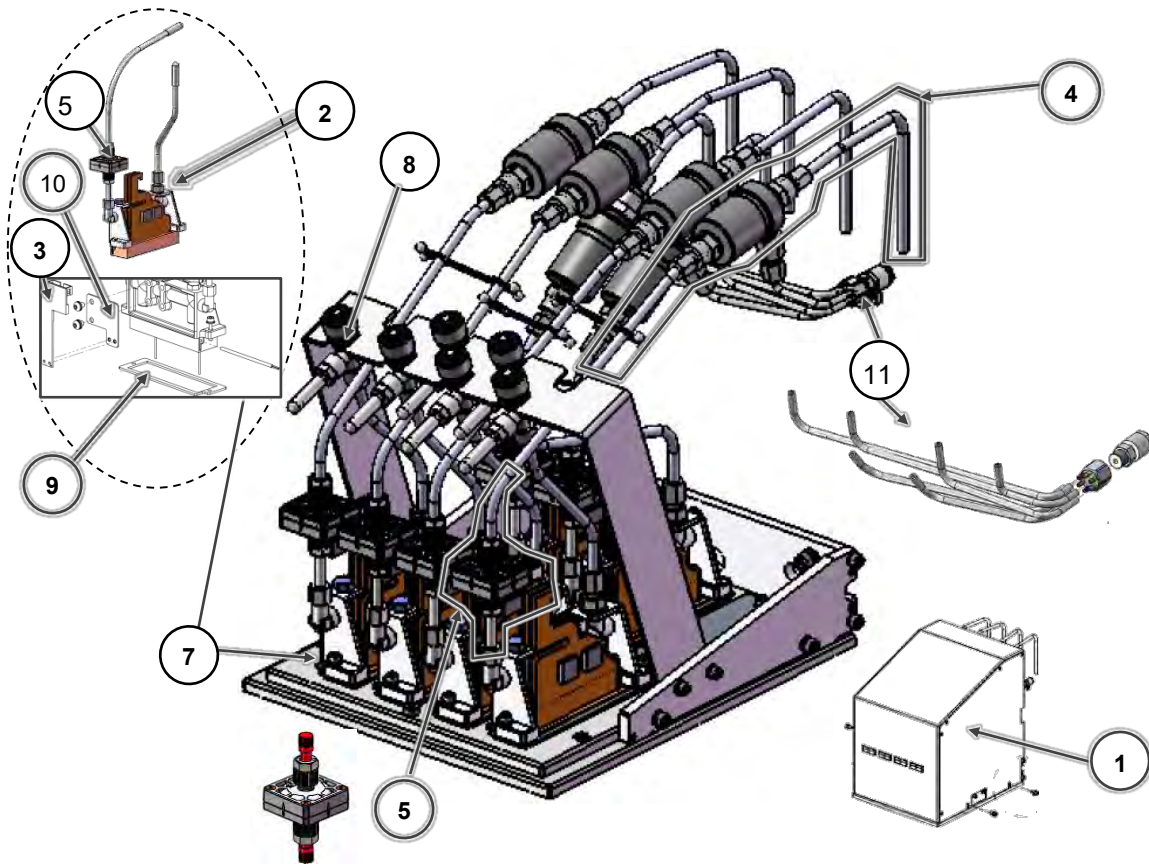



## Print Heads Array Assembly (33-PHAS-0006)

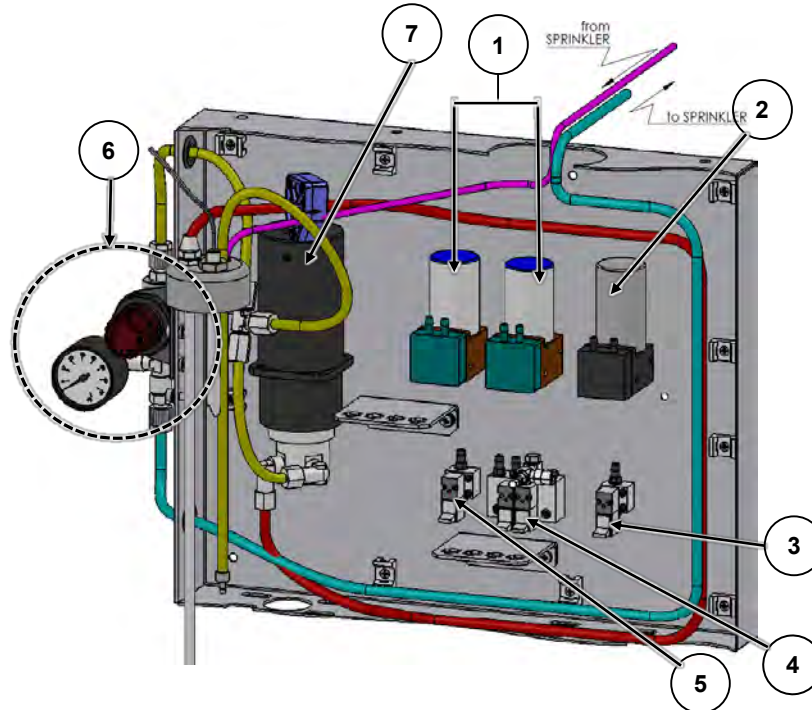

#	Catalog #	Description	
1	33-COVR-0053	Heads Cover Assembly	
2	33-HEAD-1921	New Print Head Incl. Bracket	
3	06-EBRD-0205	Head Adaptor (Dongle) Board	
4	33-DGAS-0005	Degassing Cartridge Assembly	
5	33-FLTR-0280	28mm Filter & Plugs	
5A	03-RING-0106	Compression Ferrule 10 Bar 6.4X8.6mm	
5B	03-NUTT-0007	Knurled Nut 10 bar 10X1 14.5X14mm (Serto)	
6	09-CABL-0106	Head Data Cable (not shown)	
7	09-KEAS-0210	Cable K-EAS-10 PH Heater & Sensor (Heating Element for the Heads)	
8	33-VALV-0011-S	Manual Purge Valve	
9	39-SPAC-0010	2mm Spacer	
10	39-COVR-0098	Dongle Bracket Assembly	
11	33-MNFD-0056	Vacuum Manifold	





## Pneumatic Panel (33-ELEC-0003)

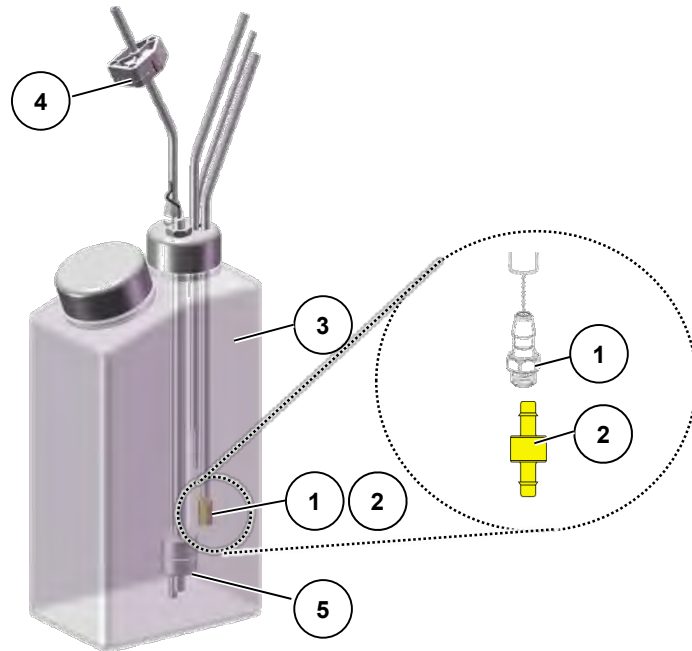

#	Catalog #	Description	
1	09-KEAS-1228	Vacuum/Purge Pump incl. Connector/Cable for Service - Wired	
2	09-KEAS-0227-S	Degassing pump - Wired	
3	09-KEAS-0234	Single Place Valve Manifold Assembly (N.O.) – Wired	
4	09-KEAS-1235	2-Places Vacuum Relief Valve Manifold Assembly – Wired	
5	09-KEAS-0236-S	Single Place Leak Valve Manifold Assembly (N.C.) – Wired (no bolt)	
6	33-SPRG-0011	Spray System Pressure Regulator	
7	23-UPGR-0035	Upgrade kit for Fixation Pump V3 Replacement	

## Spray Container Tank Assembly (33-SPRY-0018)



#	Catalog #	Description	
1	03-CONC-0015	10-32 UNF Thread to Barb 3 mm ID Tubing	
2	03-ORIF-0001	Spray Tank Orifice Coupling .030"	
3	17-TANK-0003	Spray Container Tank 3L	
4	33-FLTR-0014	Spray Filter Assy 105 Mic. Blue color	
5	23-UPGR-0025	Wired Spray Tank Level Sensor Float (Replaces Cable K-EAS-30 Main Spray Tank Level)	
6	23-UPGR-0026	Spray Container Float Upgrade for 921 (Partial) (Not Shown)	

## Right View

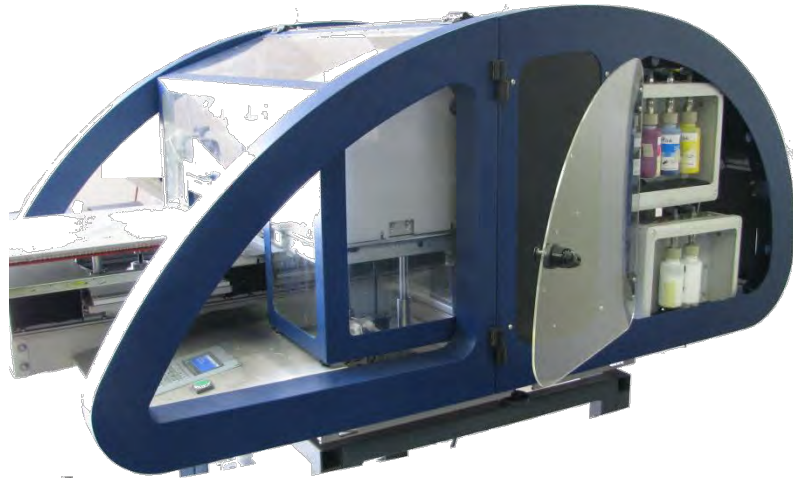





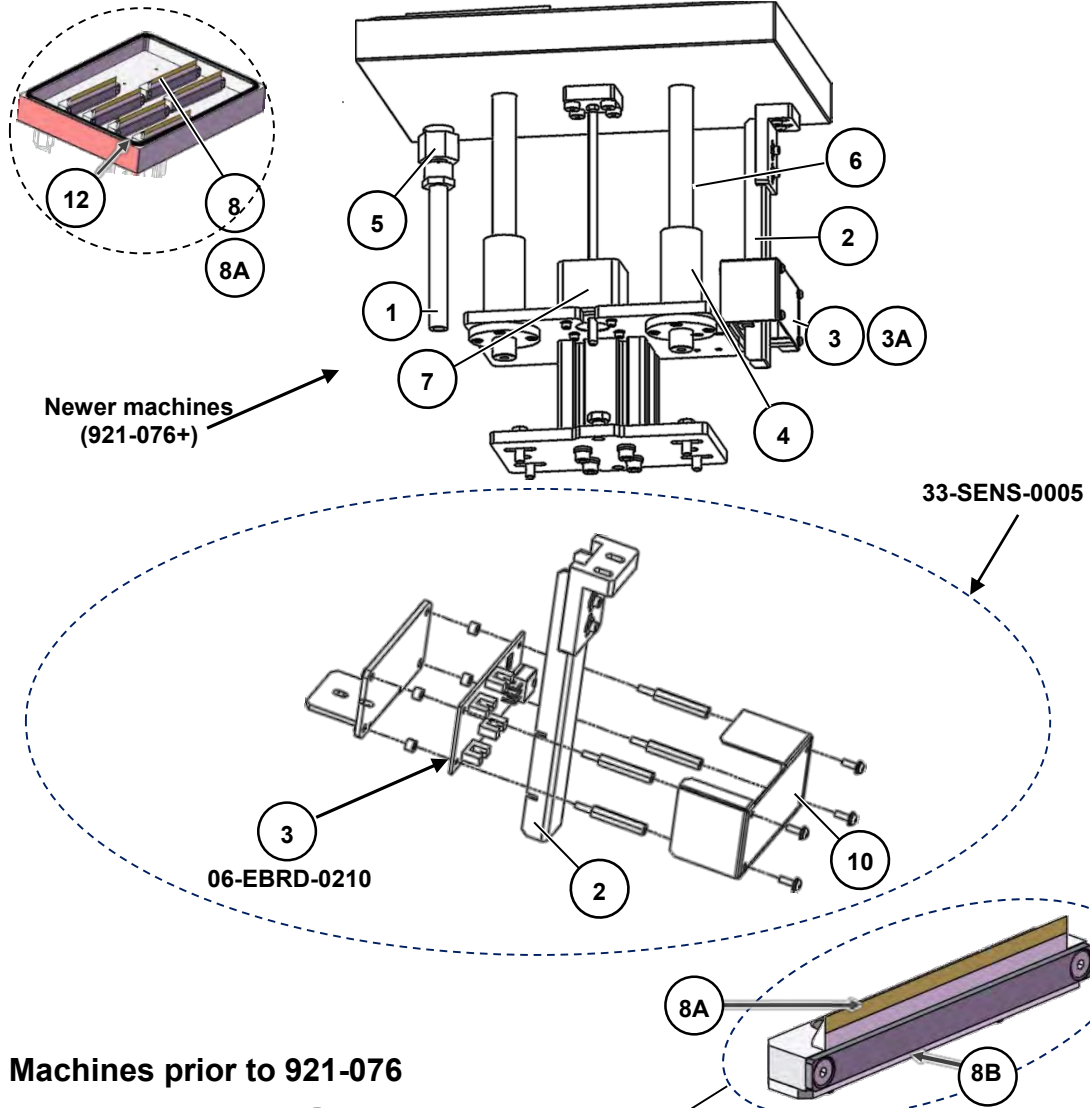

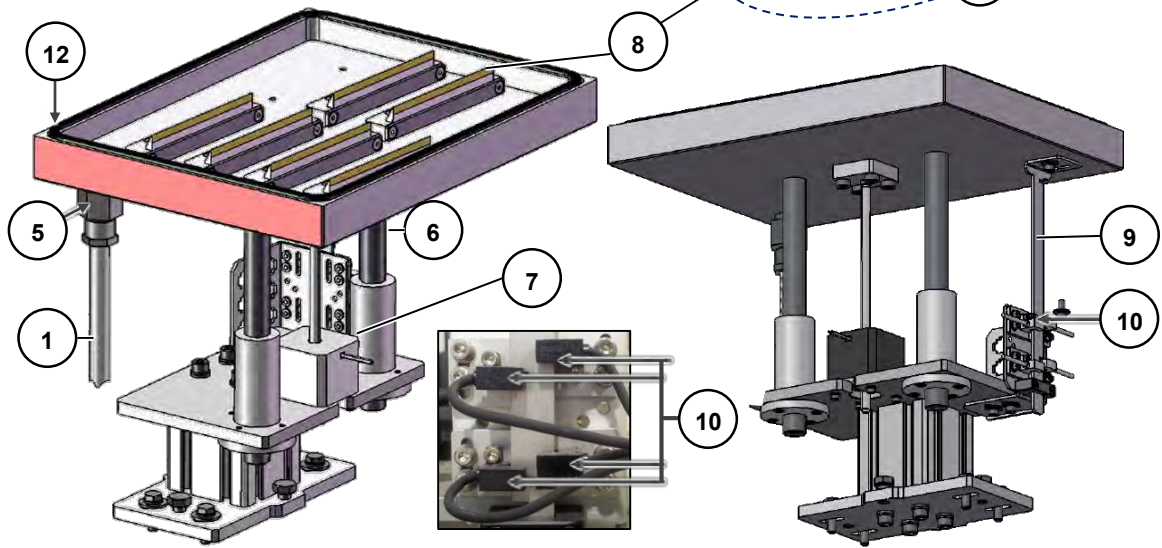

# Maintenance Assembly (33-MAIN-0015)

## Machines 921-076+







## Machines prior to 921-076

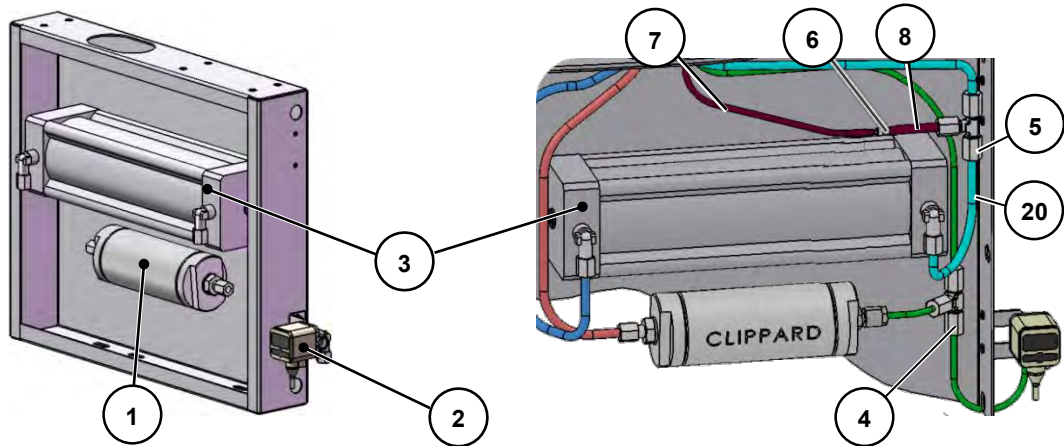

#	Catalog #	Description	
1	03-PIPE-0016	Flexible Tube Technoflex 5/16 " x 5 m	
2	39-BRAK-0160	Maintenance Sensors Flag Bracket	
3	09-KEAS-1226	Maintenance Position Sensor Cable Assembly K-EAS-26 (for Service). (For sensor board for determining place of maintenance piston)	
	06-EBRD-0210	Maintenance Sensor Assembly – from machine 921-076	
4	42-LNBR-1670	Linear Bearing - Round Flange Type	
5	03-CONC-1212	Straight ½ - 12 Connection	
6	36-SHAF-0022	Maintenance Shaft	
7	09-KEAS-1204	Z Motor Cable Assembly (incl. plug)	
8	33-WIPR-0033	Wiper Assembly (Ink)	
8A	36-WIPR-0058	Wiper Blade	
8B	39-SPAC-0017	Wiper Spacer – for machines serial no.: 921-076+	
9	39-FLAG-0010	921 Maintenance Sensors Flag	
10	09-KEAS-0226	Limit Sensor Cable K-EAS-26 (Cap Up,Down,Spit,Wipe)	
11	39-BRAK-0178	PCB Cover Bracket	
12	03-SEAL-0970	Maintenance Capping Seal EPDM105 + P61 970X5X5	

## Secondary Pneumatic Panel Assembly (33-ELCS-0001)



#	Catalog #	Description	
1	33-VACU-0013	Small Vacuum Cont. Assembly 921	
2	09-KEAS-1061	Digital Pressure Switch Assembly	
3	33-VACU-0012	921 Vacuum Container Assembly	
4	03-ADAP-0034	PA Plastic Tee Union	
5	03-CONC-0010	PA Plastic Tee Union	
6	03-FITG-0004	Straight Fitting 6 TO 4 OD Tubing	
7	03-PIPE-0015	Ultra Soft Tube 4 x 2 754 lg. 1/16" ID 3/16' OD	
8	03-PIPE-0064	ZEC Tube 6 x 4	



# Rear View (Internal)

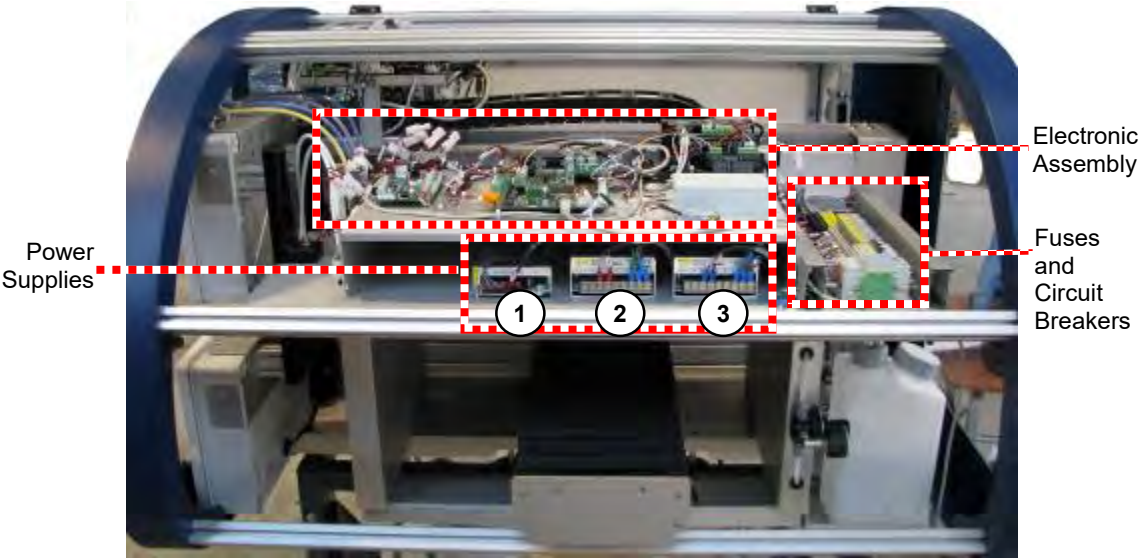

## Power Supplies

#	Catalog #	Description
1	06-PWSP-0203	Power Supply 12V SWS Series
2	06-PWSP-0201	Power Supply 24V SWS Series
3	06-PWSP-0202	Power Supply 36V SWS Series

## Fuses and Circuit Breakers









1

2



3

4

#	Catalog #	Description	
1	06-CBRK-0062	Circuit Breakers 6A 2 Pole	
2	06-RELY-0001	Relay DP 5A 24VDC-RoSH	 ← 06-RELY-0002      06-RELY-0001 →
2A	06-RELY-0002	Relay Socket DIN-RoSH	
3	05-FUSE-0003	215 Series – 5 x 20mm Ceramic Body Time-Lag Cart. <b>3A</b> (F8)	
3A	05-FUSE-0004	5 x 20 mm Time Lag Fuse (Slo-Blo®) Fuse 213 <b>10A</b> (F5)	
3B	05-FUSE-0005	5 x 20 mm Time Lag Fuse (Slo-Blo®) <b>5A</b> (F2, F3, F6, F9)	
3C	05-FUSE-0007	5 x 20 mm Time Lag Fuse (Slo-Blo®) <b>1A</b> (F1, F4, F7)	
4	06-CONM-0227	Terminal Block UDK4	
5	06-CONT-0020	Controller DVP14SS11R (not shown in picture above)	
6	06-RELY-0004	Extension for Controller 8in + 8out (DVP16)	

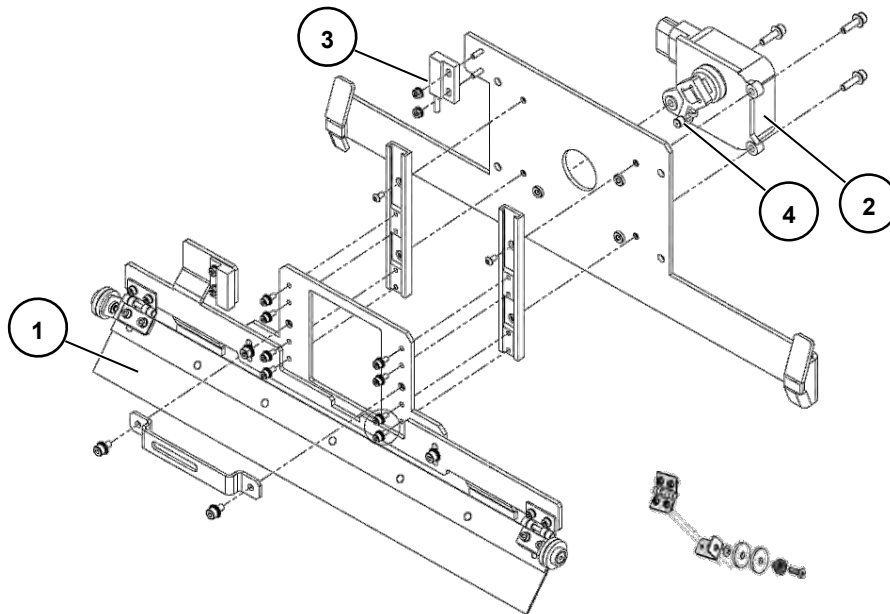

## Wiping System (33-WIPR-0027)



#	Catalog #	Description	
1	33-WIPR-0025	Spray Wiper Assembly	
2	42-MOTR-0009	DC Motor with Transmission 22W (without Bracket)	
3	09-KEAS-1233	Wiper On/Off Switch - Wired	
4	33-ARMM-0009	Arm Assembly	

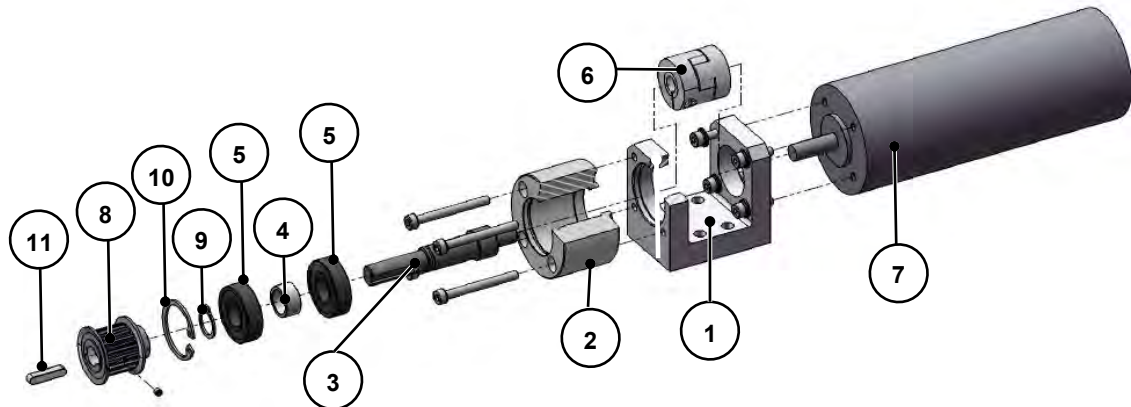







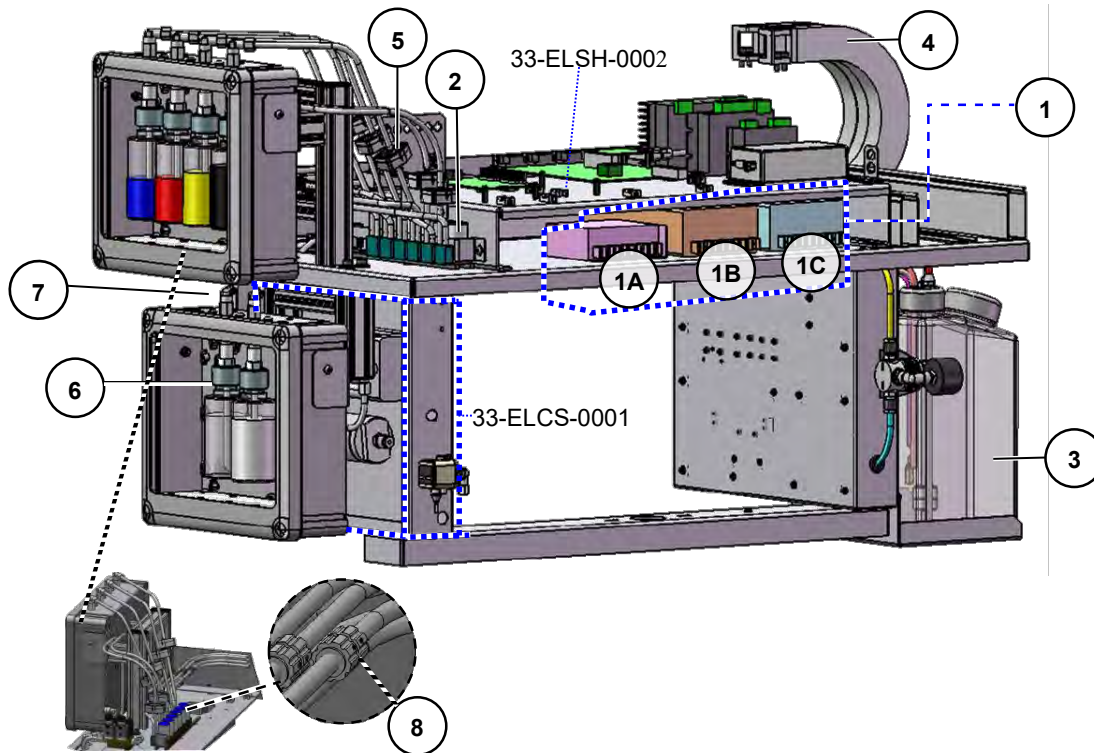

## Motor Gear Assembly (33-GEAR-0005)



#	Catalog #	Description	
1	36-BRAK-0091	Motor Bracket	
2	36-HOUS-0023	Bearing Housing	
3	36-SHFT-0016	Pulley Shaft	
4	36-SPAC-0039	Bearing Spacer	
5	42-BEAR-6001	NSK Ball Bearing	
6	42-COUP-0009	Coupling	
7	09-KEAS-1201	DC Motor Cross-scan Axis Cable Assembly	
8	42-PULY-0014	Pulley	
9	45-CIRC-0012	Circlips DIN 471 - 12 x 1	
10	45-OCIR-0028	Circlips DIN 472 - 28 x 1.2	
11	45-PKEY-4420	Parallel Key A4 x 4 x 20	







## Electrical System V1 (33-ELEC-0002)

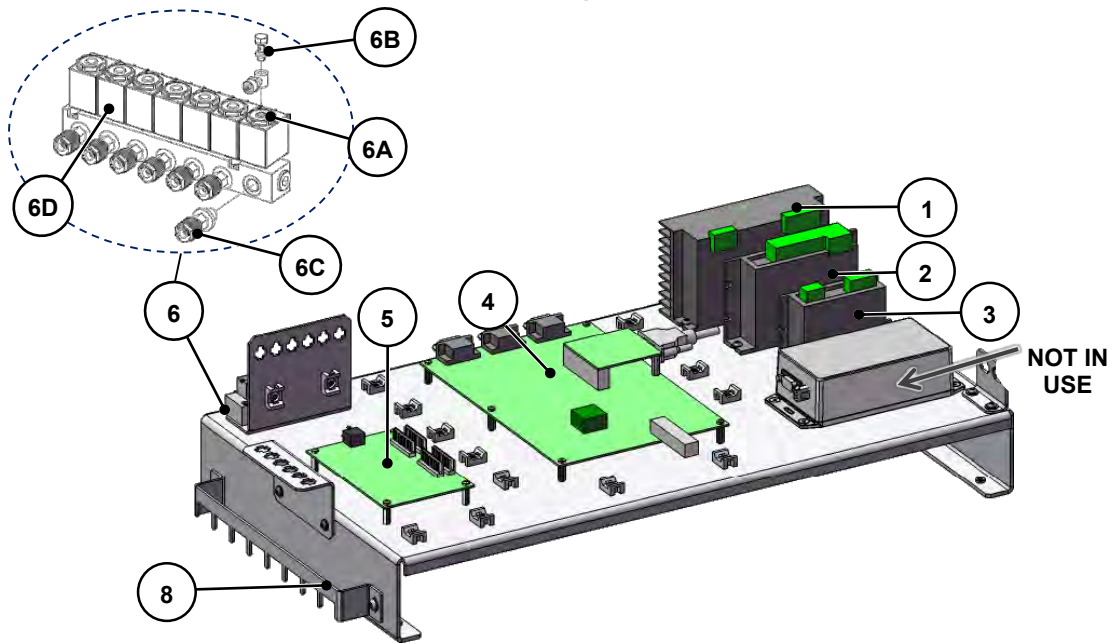

#	Catalog #	Description	Image
1	Power Supplies		
1A	06-PWSP-0203	Power Supply 12V SWS Series	
1B	06-PWSP-0201	Power Supply 24V SWS Series	
1C	06-PWSP-0202	Power Supply 36V SWS Series	
2	09-KEAS-0224-S	Ink Pump 24V with Connector	
3	33-SPRY-0018	Spray Container Tank Assembly	
4	42-CBLC-0038	Cable Carrier	
5	33-FLTR-0280	28mm Filter with Plugs	
6	33-BOTL-0001	Bottle Connector Assembly	
7	33-CONN-0002	Lower Connection Assembly	
8	03-VALV-0021	Miniature One-way Check Valve #502	

## Electrical Upper Shelf Assembly (33-ELSH-0002)



#	Catalog #	Description	Image
1	06-DRIV-0201	Driver for 2-Phase Hybrid Stepper	
2	23-UPGR-0022	Scan Axis Servo Driver Kit	
3	06-DRIV-0203	M415B Micro-stepping Driver	
4	06-EBRD-0201	Main Board	
5	23-UPGR-0023	NP board - Installation Kit	
6	33-MNFD-0042	7-Place Manifold (Valid from Machine no. 921-076 and up).	
6A	45-BANJ-1610	Banjo 6mm M5 1 SIDE	
6B	03-FITG-0007	Rapid Fitting	
6C	03-ADAP-0187	Straight Connector. WEPDM SealL 1/8"-6	
6D	03-COIL-0002	Air Manifold Coil (2.5W)	
7	23-UPGR-0027	Air Manifold Upgrade for 921 (for machines with older manifold type)	
8	39-HOLD-0090	Ink Pump Holder	